

cetof



CATALOGO - CATALOGUE

2021



pg 9



pg 11



pg 15



pg 19

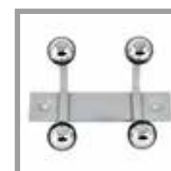

pg 26



magnetico

pg 27



pg 29



pg 35



pg 36



pg 36



pg 38



APPENDIABITI - COAT STANDS

4



APPENDIABITI IN LEGNO - WOODEN COAT STANDS

16



OMINI PORTA ABITI - CLOTHES HANGERS

20



CESTINI - WASTE BINS

21



PORTAOMBRELLI - UMBRELLA HOLDERS

24



KIT SCRIVANIA - OFFICE DESK KITS

25



APPENDINI A MURO - WALL HANGERS

26



TAVOLI - TABLES

30



SPECCHIERE - FLOOR STANDING MIRRORS

31



VESTIARI - WARDROBES

32



SEDIE - CHAIRS

36



PANCHE - WAITING ROOM CHAIRS

38



CODICE ARTICOLO - ARTICLE CODE

101

DESCRIZIONE - DESCRIPTION

Appendiabito verniciato o cromato con dettagli in plastica

Varnished or chromed coat stand with plastic fittings

COLORI - COLOURS

argento - silver
bianco - white
nero - black
rosso - red

DETTAGLI TECNICI - TECHNICAL DATA

pezzi per scatola - pcs per box: **01**
peso lordo - gross weight: **4.70 Kg**

IMBALLO - PACKING

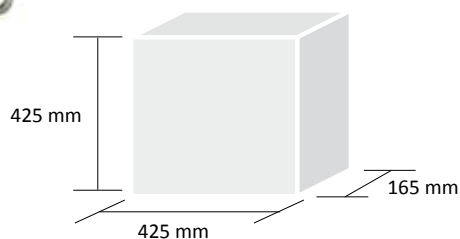

cromato - chromed



CODICE ARTICOLO - ARTICLE CODE

101 MIX

DESCRIZIONE - DESCRIPTION

Appendiabito verniciato argento con plastiche colorate

Silver varnished coat stand with colored plastic fittings

COLORI - COLOURS

arancione - orange
blu - blue
giallo - yellow
nero - black
rosso - red
verde - green

DETTAGLI TECNICI - TECHNICAL DATA

pezzi per scatola - pcs per box: **01**
peso lordo - gross weight: **6.32 Kg**

IMBALLO - PACKING

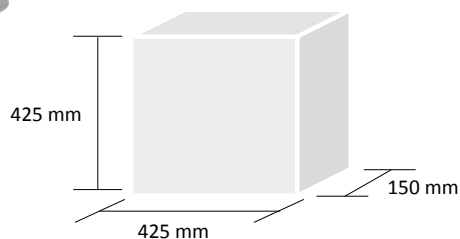

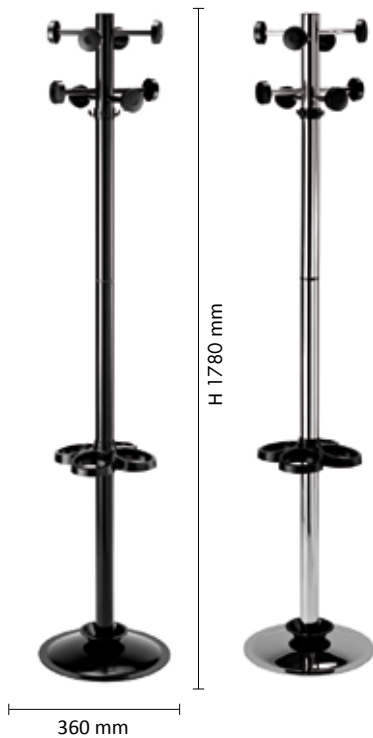

CODICE ARTICOLO - ARTICLE CODE

130

DESCRIZIONE - DESCRIPTION

Appendiabito in metallo in tre versioni: verniciato nero, cromato con piastra nera oppure tutto cromato

Metal coat stand in 3 models: black varnished, chromed with black basement or all chromed

COLORI - COLOURS

nero - black

DETTAGLI TECNICI - TECHNICAL DATA

pezzi per scatola - pcs per box: **01**
peso lordo - gross weight: **6.30 Kg**

IMBALLO - PACKING

cromato con piastra verniciata nera
chromed with black varnished basement

tutto cromato - all chromed

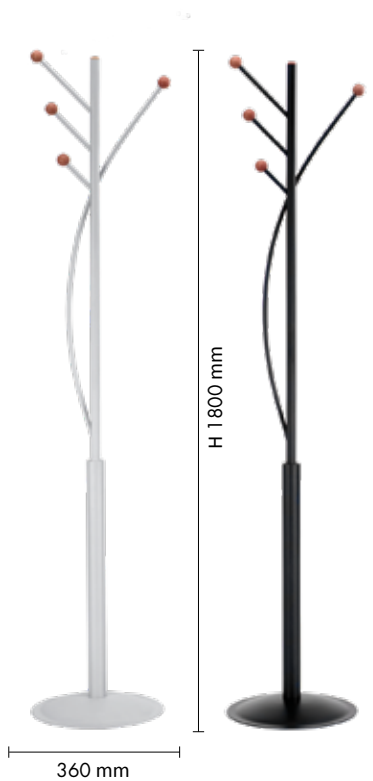
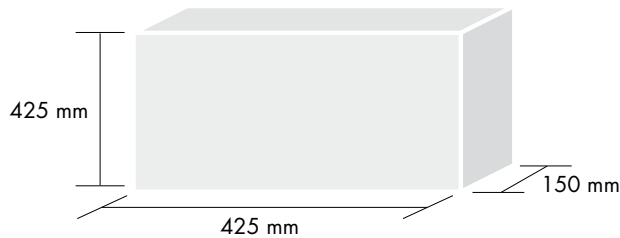

CODICE ARTICOLO - ARTICLE CODE

235 LUNA

DESCRIZIONE - DESCRIPTION

Appendiabito in metallo con dettagli in legno

Metal coat stand with wooden fittings

COLORI - COLOURS

argento - silver
nero - black

DETTAGLI TECNICI - TECHNICAL DATA

pezzi per scatola - pcs per box: **01**
peso lordo - gross weight: **5.60 Kg**

IMBALLO - PACKING

argento - silver
nero - black

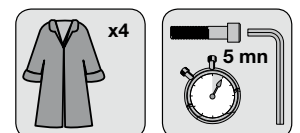
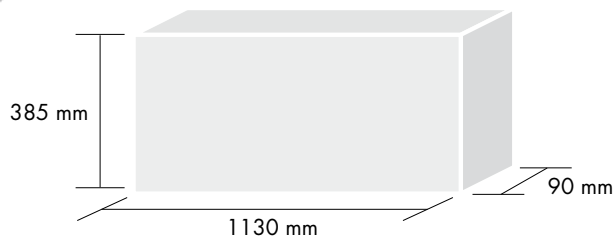



CODICE ARTICOLO - ARTICLE CODE

260 BISTROT

DESCRIZIONE - DESCRIPTION

Appendiabito in metallo verniciato

Metal varnished coat stand

COLORI - COLOURS

bianco - white

nero - black

DETTAGLI TECNICI - TECHNICAL DATA

pezzi per scatola - pcs per box: **01**

peso lordo - gross weight: **6.11 Kg**

IMBALLO - PACKING

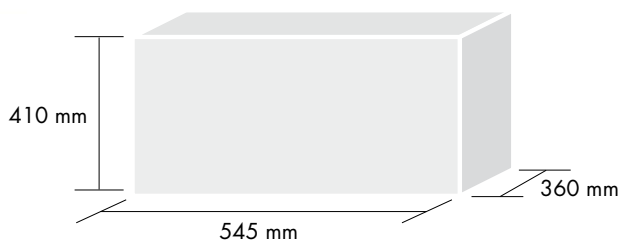

CODICE ARTICOLO - ARTICLE CODE

530 DALLAS

DESCRIZIONE - DESCRIPTION

Appendiabito in metallo verniciato con inserti in legno e portaombrelli

Metal varnished coat stand with wooden fittings and umbrella holder

COLORI - COLOURS

argento - silver

nero - black

DETTAGLI TECNICI - TECHNICAL DATA

pezzi per scatola - pcs per box: **01**

peso lordo - gross weight: **6.21 Kg**

IMBALLO - PACKING

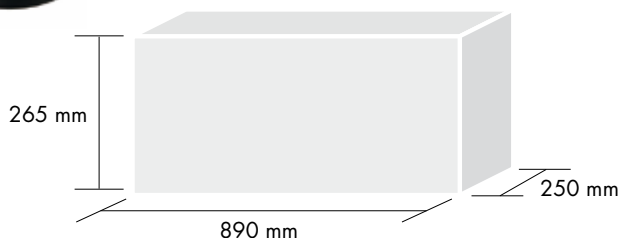



CODICE ARTICOLO - ARTICLE CODE

540 ORIONE

DESCRIZIONE - DESCRIPTION

Appendiabito in metallo verniciato con inserti in legno e portaombrelli

Metal varnished coat stand with wooden fittings and umbrella holder

COLORI - COLOURS

argento - silver
nero - black

DETTAGLI TECNICI - TECHNICAL DATA

pezzi per scatola - pcs per box: **01**
peso lordo - gross weight: **6.06 Kg**

IMBALLO - PACKING

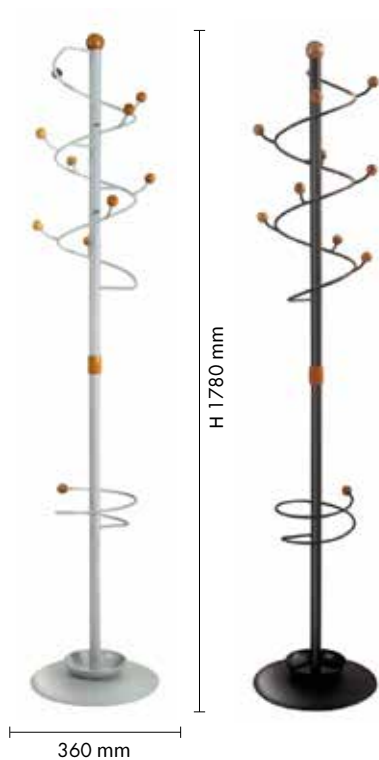
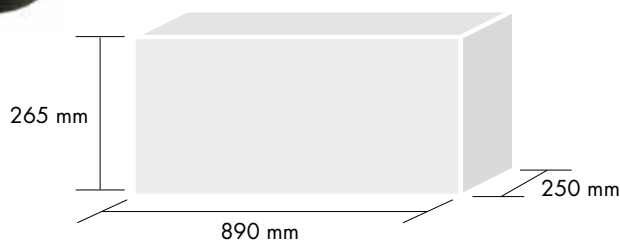

CODICE ARTICOLO - ARTICLE CODE

604 VORTICE

DESCRIZIONE - DESCRIPTION

Appendiabito in metallo verniciato con inserti in legno e portaombrelli

Metal varnished coat stand with wooden fittings and umbrella holder

COLORI - COLOURS

argento - silver
nero - black

DETTAGLI TECNICI - TECHNICAL DATA

pezzi per scatola - pcs per box: **01**
peso lordo - gross weight: **7.71 Kg**

IMBALLO - PACKING

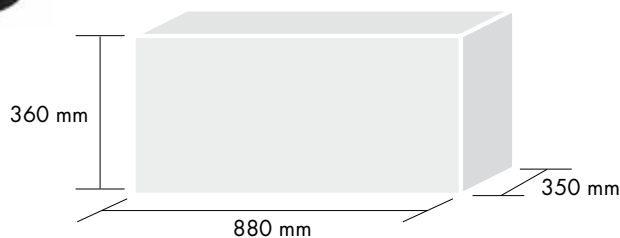



CODICE ARTICOLO - ARTICLE CODE

620 VULCANO

DESCRIZIONE - DESCRIPTION

Appendiabito in metallo verniciato con inserti in legno e portaombrelli

Metal varnished coat stand with wooden fittings and umbrella holder

COLORI - COLOURS

argento - silver
nero - black

DETTAGLI TECNICI - TECHNICAL DATA

pezzi per scatola - pcs per box: **01**
peso lordo - gross weight: **7.7 Kg**

IMBALLO - PACKING

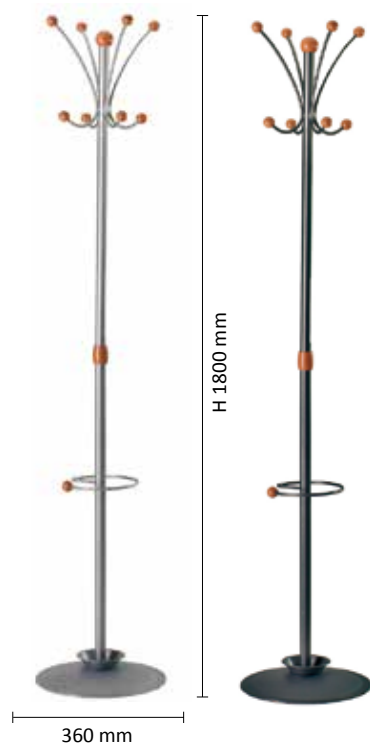
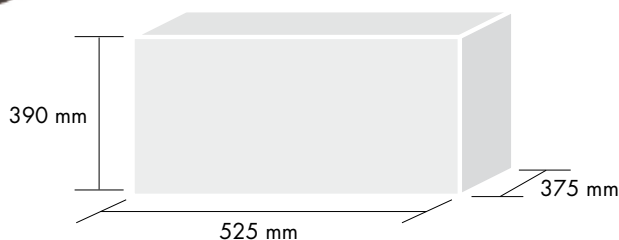

CODICE ARTICOLO - ARTICLE CODE

640 ORO

DESCRIZIONE - DESCRIPTION

Appendiabito in metallo verniciato con inserti in legno e portaombrelli

Metal varnished coat stand with wooden fittings and umbrella holder

COLORI - COLOURS

argento - silver
nero - black

DETTAGLI TECNICI - TECHNICAL DATA

pezzi per scatola - pcs per box: **01**
peso lordo - gross weight: **6.25 Kg**

IMBALLO - PACKING

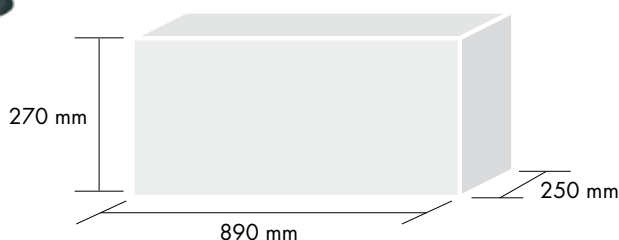

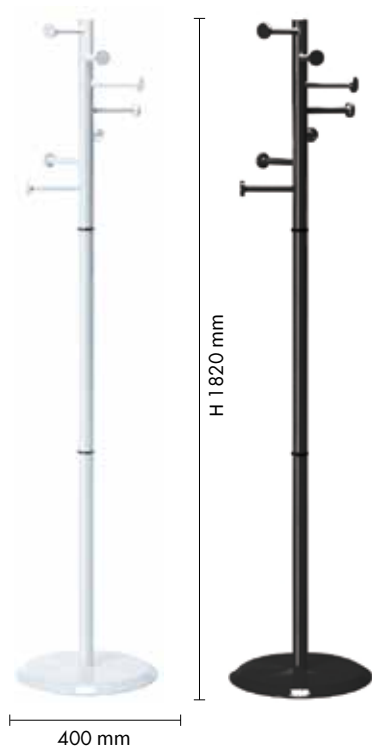

CODICE ARTICOLO - ARTICLE CODE

802 PRIMULA

DESCRIZIONE - DESCRIPTION

Appendiabito in metallo verniciato

Metal varnished coat stand

COLORI - COLOURS

bianco - white

nero - black

DETTAGLI TECNICI - TECHNICAL DATA

pezzi per scatola - pcs per box: **01**

peso lordo - gross weight: **8.25 Kg**

IMBALLO - PACKING

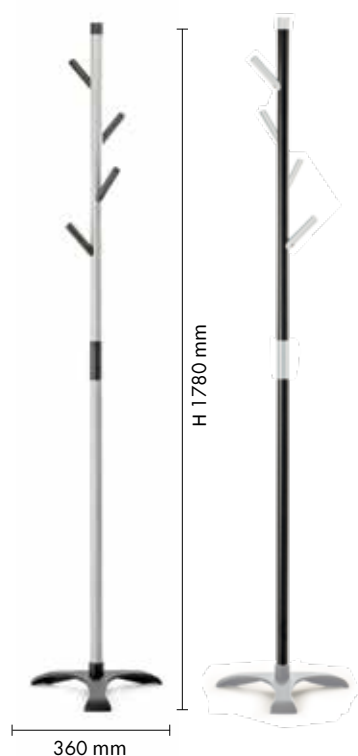
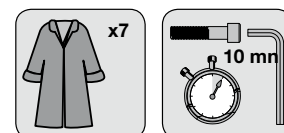
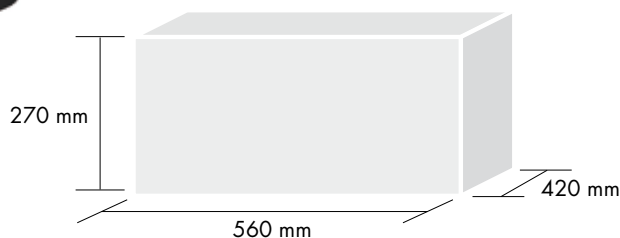

CODICE ARTICOLO - ARTICLE CODE

810 BRANCH

DESCRIZIONE - DESCRIPTION

Appendiabito in metallo verniciato

Metal varnished coat stand

COLORI - COLOURS

argento (pomoli neri)

silver (black hooks)

bianco (pomoli neri)

white (black hooks)

nero (pomoli argento)

black (silver hooks)

DETTAGLI TECNICI - TECHNICAL DATA

pezzi per scatola - pcs per box: **01**

peso lordo - gross weight: **5,01Kg**

IMBALLO - PACKING

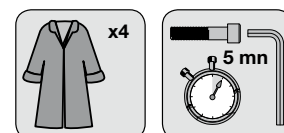
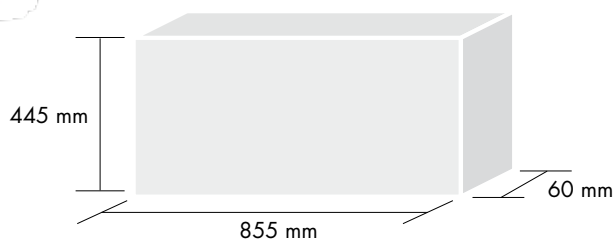



CODICE ARTICOLO - ARTICLE CODE

820 GISELLE

DESCRIZIONE - DESCRIPTION

Appendiabito verniciato con accessori in legno e vaschetta raccogli gocce in plastica

Varnished coat stand with wooden fittings and plastic drop tray

COLORI - COLOURS

argento (accessori ciliegio)
silver (cherry wooden fittings)

bianco (accessori ciliegio)
white (cherry wooden fittings)

nero (accessori faggio)
black (beech wooden fittings)

DETTAGLI TECNICI - TECHNICAL DATA

pezzi per scatola - pcs per box: **01**
peso lordo - gross weight: **8.35 Kg**

IMBALLO - PACKING

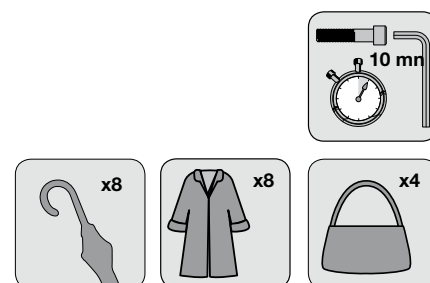
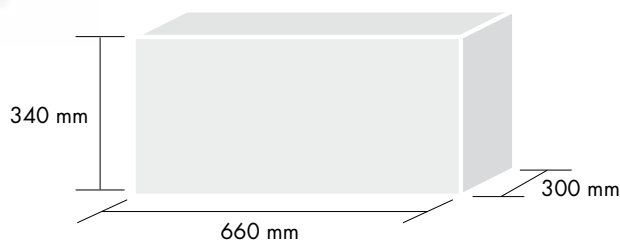

CODICE ARTICOLO - ARTICLE CODE

830 SOLEIL

DESCRIZIONE - DESCRIPTION

Appendiabito verniciato con accessori in faggio o ciliegio e testa girevole

Varnished coat stand with beech or cherry wooden fittings and revolving head

COLORI - COLOURS

argento - *silver*

bianco - *white*

nero - *black*

DETTAGLI TECNICI - TECHNICAL DATA

pezzi per scatola - pcs per box: **01**
peso lordo - gross weight: **6.76 Kg**

IMBALLO - PACKING

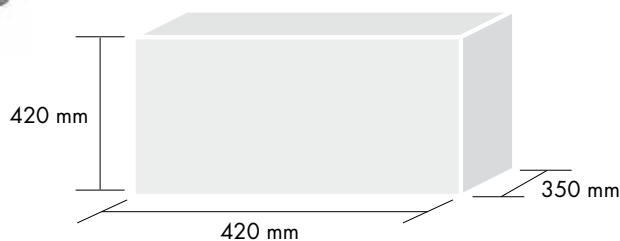

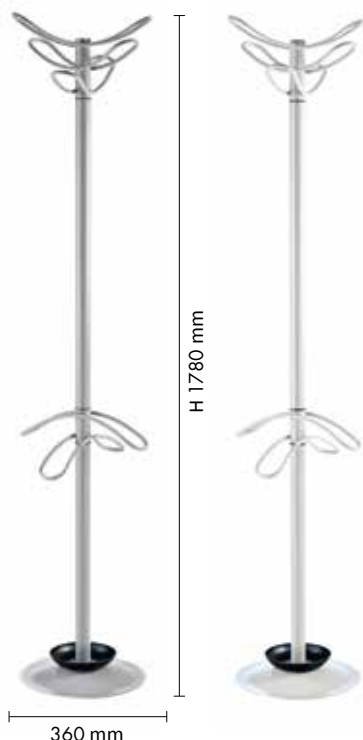

CODICE ARTICOLO - ARTICLE CODE

860 GILDA COLOR

DESCRIZIONE - DESCRIPTION

Appendiabito in metallo verniciato con portaombrelli in metallo e vaschetta raccogliogocce in plastica

Metal varnished coat stand with metal umbrella holder and plastic drop tray

COLORI - COLOURS

grigio - grey
bianco - white

DETTAGLI TECNICI - TECHNICAL DATA

pezzi per scatola - pcs per box: **01**
peso lordo - gross weight: **7 Kg**

IMBALLO - PACKING

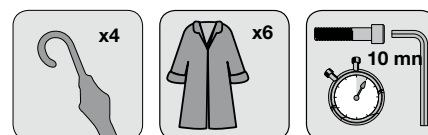
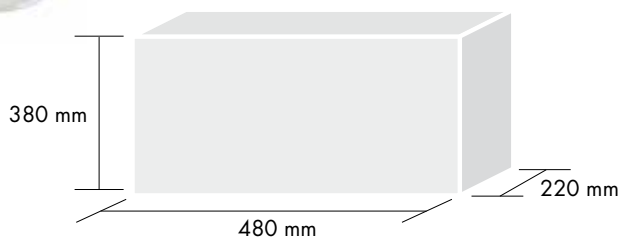

NEW

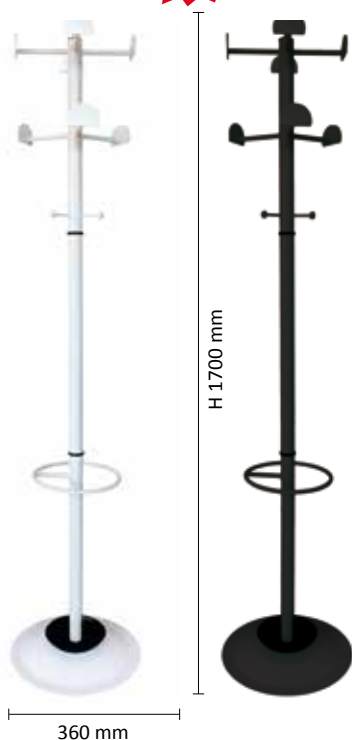

CODICE ARTICOLO - ARTICLE CODE

895 FLORA

DESCRIZIONE - DESCRIPTION

Appendiabiti in metallo verniciato
Metal varnished coat stand

COLORI - COLOURS

bianco - white
argento - silver
nero - black

DETTAGLI TECNICI - TECHNICAL DATA

pezzi per scatola - pcs per box: **01**
peso lordo - gross weight: **7.60 Kg**

IMBALLO - PACKING

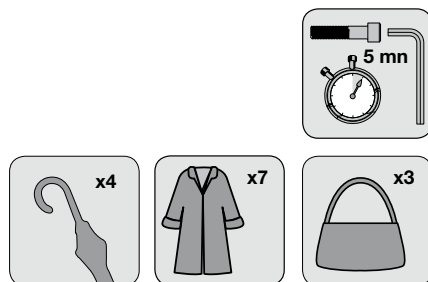
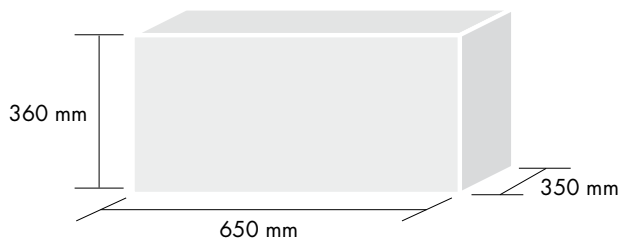



CODICE ARTICOLO - ARTICLE CODE

896 LILLY

DESCRIZIONE - DESCRIPTION

Appendiabiti in metallo verniciato con accessori in legno

Metal varnished coat stand with wooden fittings

COLORI - COLOURS

bianco/acc. legno
white/wooden fittings

argento/acc. legno
silver/wooden fittings

nero/acc. legno
black/wooden fittings

DETTAGLI TECNICI - TECHNICAL DATA

pezzi per scatola - pcs per box: **01**
peso lordo - gross weight: **6.08 Kg**

IMBALLO - PACKING

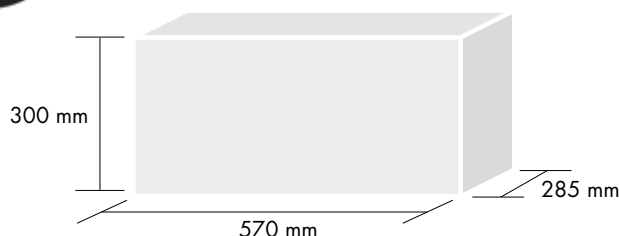

CODICE ARTICOLO - ARTICLE CODE

LUNA BIS con portaombrelli *with umbrella holder*

DESCRIZIONE - DESCRIPTION

Appendiabito verniciato con portaombrelli e accessori in legno

Varnished coat stand with umbrella holder and wooden fittings

COLORI - COLOURS

argento - silver
nero - black

DETTAGLI TECNICI - TECHNICAL DATA

pezzi per scatola - pcs per box: **01**
peso lordo - gross weight: **7.13 Kg**

IMBALLO - PACKING

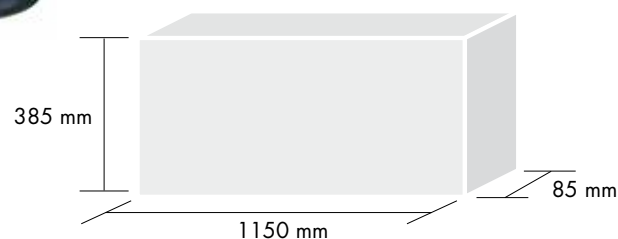

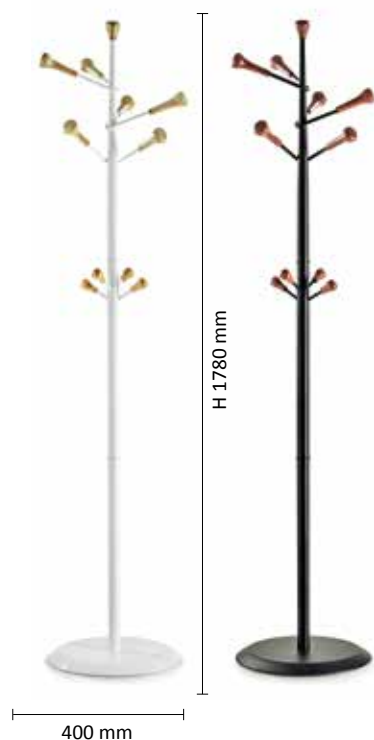

CODICE ARTICOLO - ARTICLE CODE

PETALO

DESCRIZIONE - DESCRIPTION

Appendiabito verniciato con accessori in legno

Metal varnished coat stand with wooden fittings

COLORI - COLOURS

bianco / legno
white / wooden fittings

argento / legno
silver / wooden fittings

nero / legno
black / wooden fittings

DETTAGLI TECNICI - TECHNICAL DATA

pezzi per scatola - pcs per box: **01**
peso lordo - gross weight: **8.06 Kg**

IMBALLO - PACKING

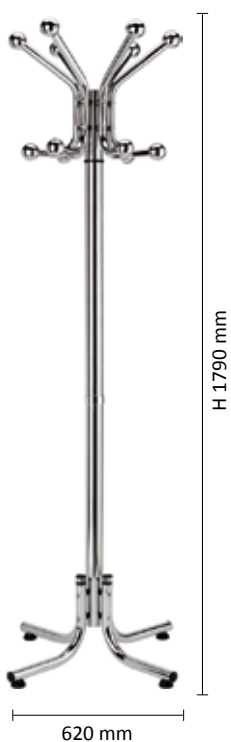
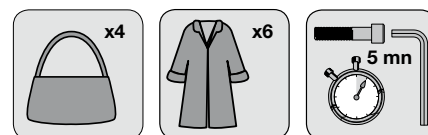
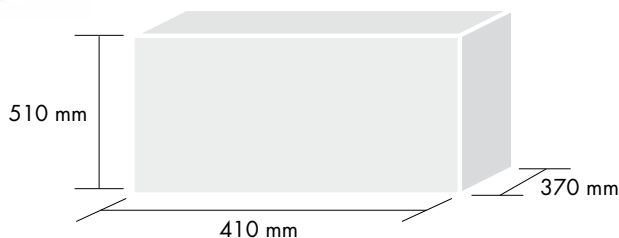

CODICE ARTICOLO - ARTICLE CODE

P121

DESCRIZIONE - DESCRIPTION

Appendiabito cromato

Chromed coat stand

COLORI - COLOURS

cromato - chromed

DETTAGLI TECNICI - TECHNICAL DATA

pezzi per scatola - pcs per box: **01**
peso lordo - gross weight: **6.55 Kg**

IMBALLO - PACKING

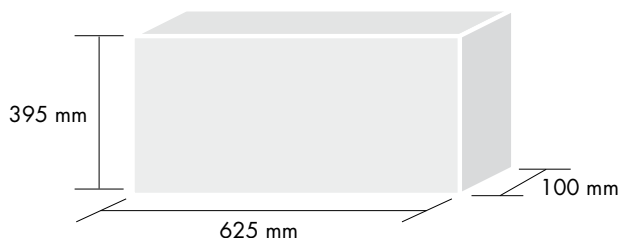

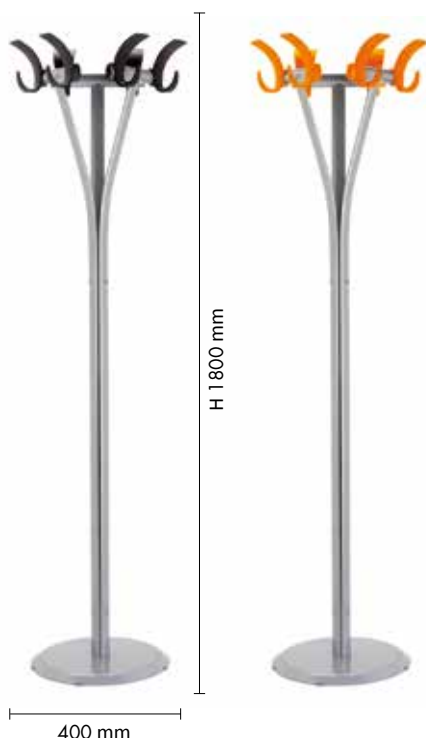

CODICE ARTICOLO - ARTICLE CODE

RICCIO A STELO

DESCRIZIONE - DESCRIPTION

Appendiabito con accessori in plastica

Coat stand with plastic fittings

DETTAGLI TECNICI - TECHNICAL DATA

pezzi per scatola - pcs per box: **01**

peso lordo - gross weight: **10 Kg**

IMBALLO - PACKING

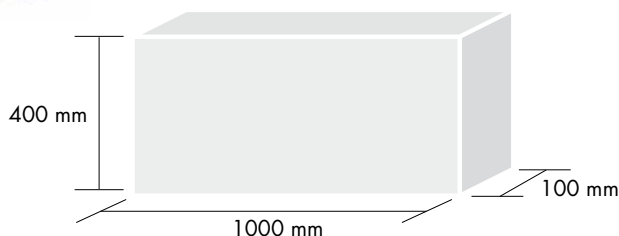

COLORI - COLOURS

grigio / accessori blu
grey with blue fittings

grigio / accessori arancioni
grey with orange fittings

grigio / accessori neri
grey with black fittings

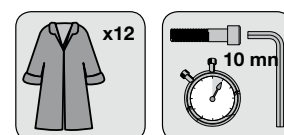

CODICE ARTICOLO - ARTICLE CODE

TULIPANO

DESCRIZIONE - DESCRIPTION

Appendiabito con base in metallo e accessori in plastica. Portaombrelli rotondo.

Coat stand with metal basement and plastic fittings. Ring umbrella holder.

DETTAGLI TECNICI - TECHNICAL DATA

pezzi per scatola - pcs per box: **01**

peso lordo - gross weight: **6 Kg**

IMBALLO - PACKING

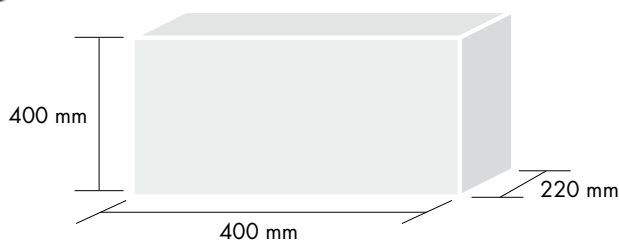

COLORI - COLOURS

cromato/accessori neri
chromed/black fittings

nero/accessori neri
black/black fittings

bianco/accessori neri
white/black fittings



NEW

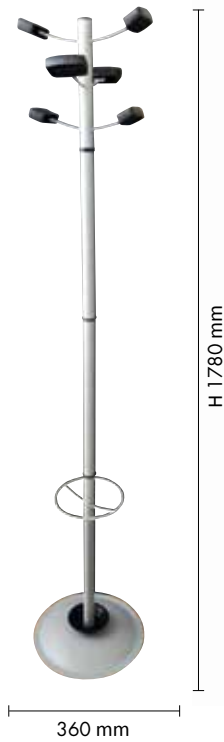

CODICE ARTICOLO - ARTICLE CODE

BEAUTY

DESCRIZIONE - DESCRIPTION

Appendiabito con base in metallo e accessori in plastica. Porta ombrelli rotondo

Coat stand with metal basement and plastic fittings. Ring umbrella holder.

COLORI - COLOURS

nero / accessori neri
black / black fittings

argento / accessori neri
silver / black fittings

DETTAGLI TECNICI - TECHNICAL DATA

pezzi per scatola - *pcs per box*: **01**

peso lordo - *gross weight*: **4.13 Kg**

IMBALLO - PACKING

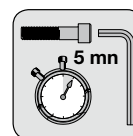
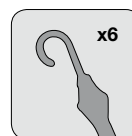
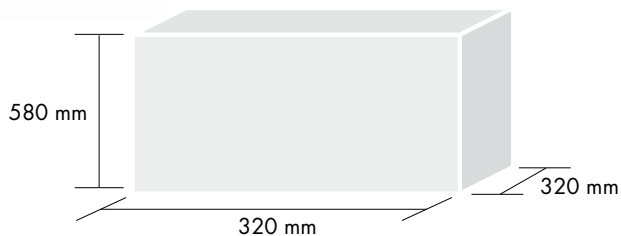

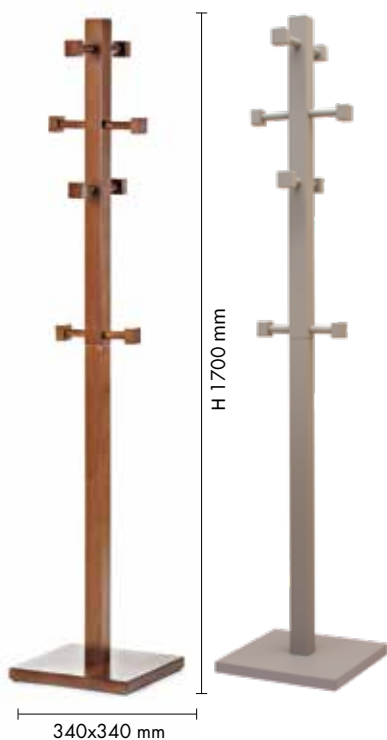

CODICE ARTICOLO - ARTICLE CODE

870 ATENA

DESCRIZIONE - DESCRIPTION

Appendiabiti in legno

Coat stand made of wood

COLORI - COLOURS

bianco - white

noce - nut

grigio - grey

tortora - beige

DETTAGLI TECNICI - TECHNICAL DATA

pezzi per scatola - pcs per box: **01**

peso lordo - gross weight: **6.50 Kg**

IMBALLO - PACKING

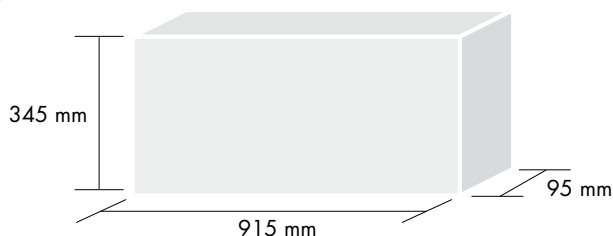

CODICE ARTICOLO - ARTICLE CODE

876 APOLLO

DESCRIZIONE - DESCRIPTION

Appendiabiti in legno

Coat stand made of wood

COLORI - COLOURS

arte povera - dark wood

DETTAGLI TECNICI - TECHNICAL DATA

pezzi per scatola - pcs per box: **01**

peso lordo - gross weight: **10 Kg**

IMBALLO - PACKING

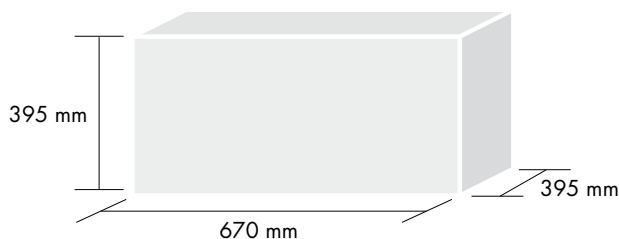

CODICE ARTICOLO - ARTICLE CODE

878 IRIDE

DESCRIZIONE - DESCRIPTION

Appendiabiti in legno

Coat stand made of wood

COLORI - COLOURS

noce - nut

avorio - ivory

DETTAGLI TECNICI - TECHNICAL DATA

pezzi per scatola - pcs per box: **03**

peso lordo - gross weight: **16 Kg**

IMBALLO - PACKING

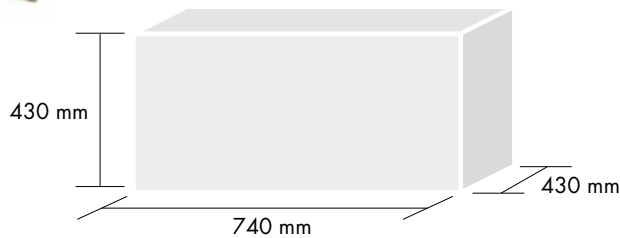

CODICE ARTICOLO - ARTICLE CODE

879 ARES

DESCRIZIONE - DESCRIPTION

Appendiabiti in legno

Coat stand made of wood

COLORI - COLOURS

arte povera - dark wood

avorio - ivory

DETTAGLI TECNICI - TECHNICAL DATA

pezzi per scatola - pcs per box: **01**

peso lordo - gross weight: **9 Kg**

IMBALLO - PACKING

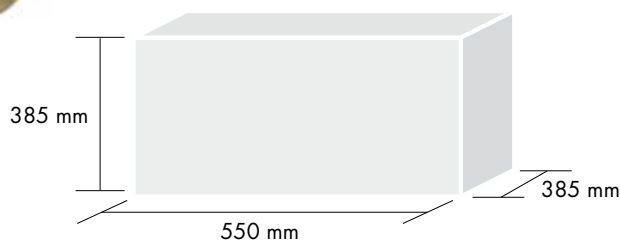

[**ELIMINATA - DELETED**]

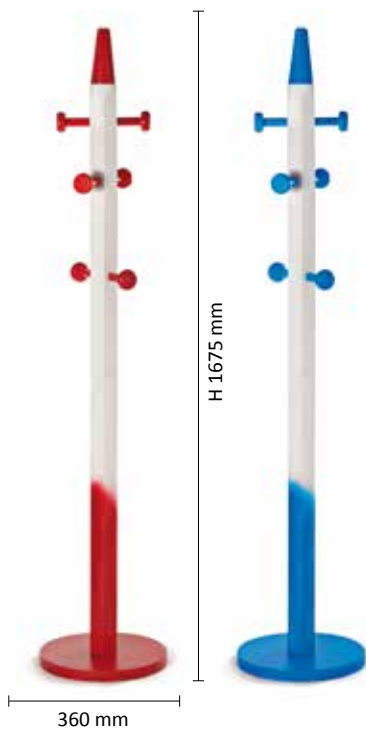

CODICE ARTICOLO - ARTICLE CODE

880 MATITA ESAGONALE

DESCRIZIONE - DESCRIPTION

Appendiabito in legno disponibile in vari colori, con pomoli rotondi

Wooden coat stand available in several colours, with round hangers

COLORI - COLOURS

blu - blue
giallo - yellow
rosa - pink
rosso - red
verde - green

DETTAGLI TECNICI - TECHNICAL DATA

pezzi per scatola - pcs per box: **04**
peso lordo - gross weight: **23.92 Kg**

IMBALLO - PACKING

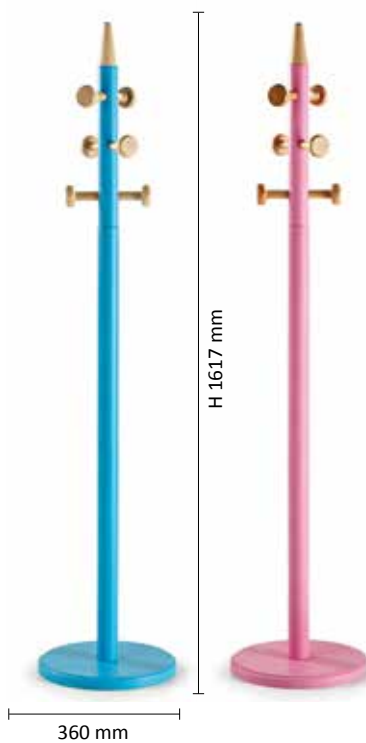
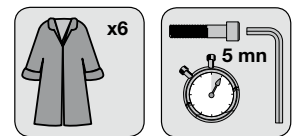
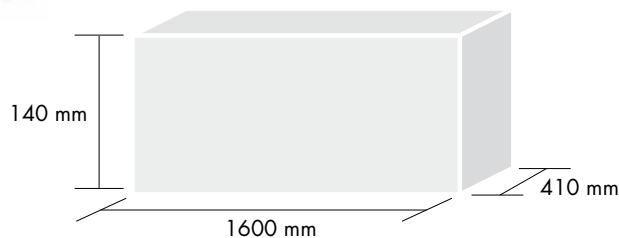

CODICE ARTICOLO - ARTICLE CODE

881 MATITA TONDA

DESCRIZIONE - DESCRIPTION

Appendiabito in legno, disponibile in vari colori, con pomoli rotondi

Wooden coat stand available in several colours, with round hangers

COLORI - COLOURS

blu - blue
giallo - yellow
rosa - pink
rosso - red
arancione - orange
verde - green

DETTAGLI TECNICI - TECHNICAL DATA

pezzi per scatola - pcs per box: **01**
peso lordo - gross weight: **5.72 Kg**

IMBALLO - PACKING

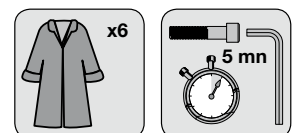
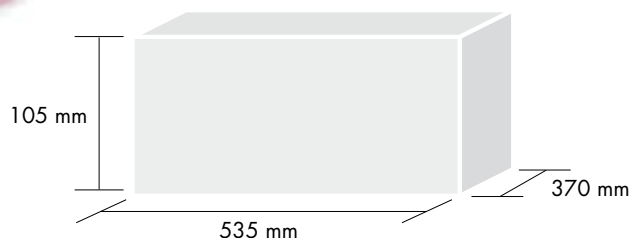

NEW

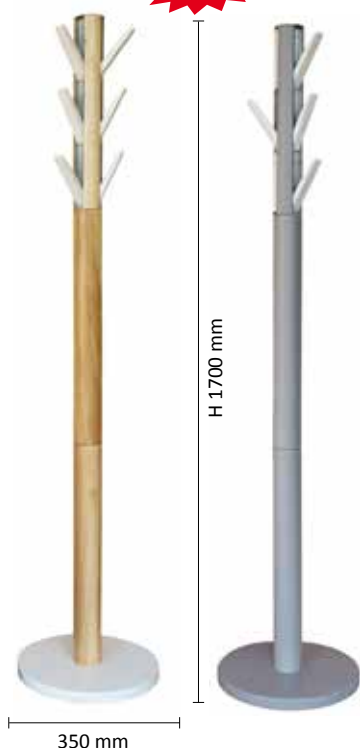

CODICE ARTICOLO - ARTICLE CODE

891 SKY A 9 POSTI

DESCRIZIONE - DESCRIPTION

Appendiabiti in legno a 9 ganci
"apri e chiudi"

Wooden coat stand with 9 flapping hooks

COLORI - COLOURS

bianco/grigio - white/grey
grigio/bianco - grey/white
naturale/bianco
natural wood/white

DETTAGLI TECNICI - TECHNICAL DATA

pezzi per scatola - pcs per box: **01**
peso lordo - gross weight: **8.75 Kg**

IMBALLO - PACKING

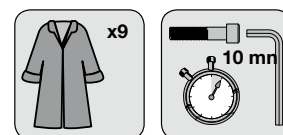
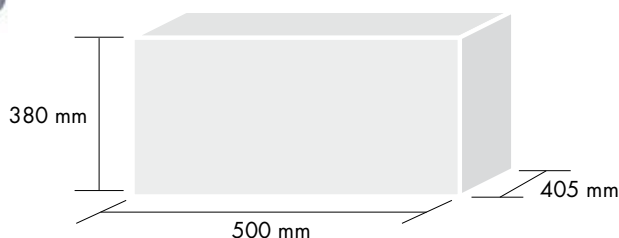

NEW

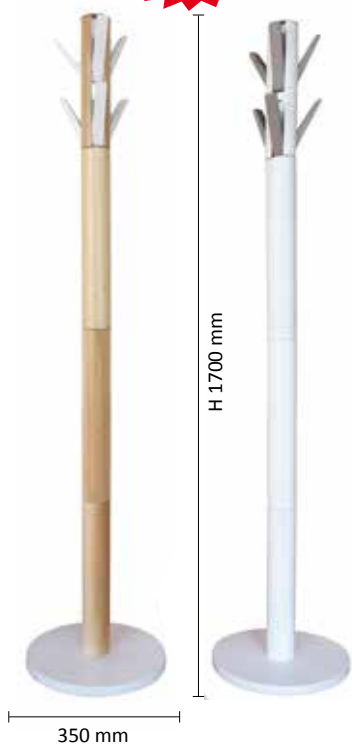

CODICE ARTICOLO - ARTICLE CODE

891 SKY A 6 POSTI

DESCRIZIONE - DESCRIPTION

Appendiabiti in legno a 6 ganci
"apri e chiudi"

Wooden coat stand with 6 flapping hooks

COLORI - COLOURS

bianco/grigio - white/grey
grigio/bianco - grey/white
naturale/bianco
natural wood/white

DETTAGLI TECNICI - TECHNICAL DATA

pezzi per scatola - pcs per box: **01**
peso lordo - gross weight: **8.75 Kg**

IMBALLO - PACKING

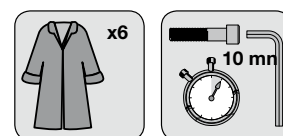
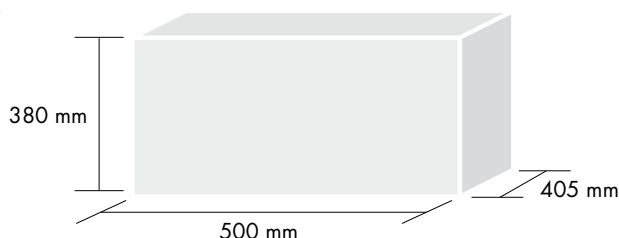



CODICE ARTICOLO - ARTICLE CODE

871 PARIDE

DESCRIZIONE - DESCRIPTION

Omino porta abiti in legno

Wooden clothes hanger

COLORI - COLOURS

bianco - white

noce chiaro - light nut color

wengé - wengé

grigio - grey

tortora - beige

DETTAGLI TECNICI - TECHNICAL DATA

pezzi per scatola - pcs per box: **01**

peso lordo - gross weight: **5.25 Kg**

IMBALLO - PACKING

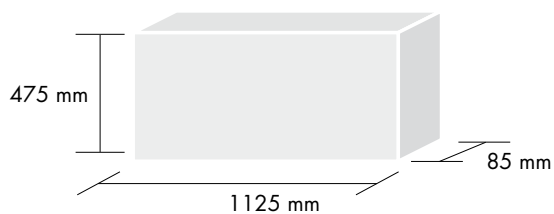



CODICE ARTICOLO - ARTICLE CODE

L3335

DESCRIZIONE - DESCRIPTION

Cestino in rete metallica traforata

Metal mesh waste bin

COLORI - COLOURS

argento - *silver*

nero - *black*

DETTAGLI TECNICI - TECHNICAL DATA

pezzi per scatola - *pcs per box*: **12**

peso lordo - *gross weight*: **7.20 Kg**

IMBALLO - PACKING

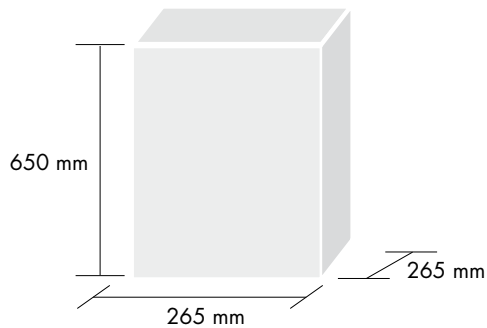

CODICE ARTICOLO - ARTICLE CODE

L3516

DESCRIZIONE - DESCRIPTION

Cestino in rete metallica traforata

Metal mesh waste bin

COLORI - COLOURS

nero - *black*

argento - *silver*

DETTAGLI TECNICI - TECHNICAL DATA

pezzi per scatola - *pcs per box*: **12**

peso lordo - *gross weight*: **7.20 Kg**

IMBALLO - PACKING

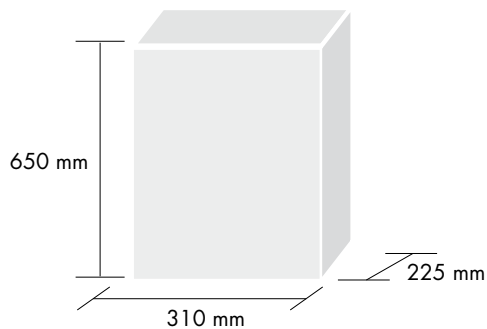



CODICE ARTICOLO - ARTICLE CODE

L5001

DESCRIZIONE - DESCRIPTION

Cestino in rete metallica traforata

Metal mesh waste bin

COLORI - COLOURS

argento - silver

nero - black

DETTAGLI TECNICI - TECHNICAL DATA

pezzi per scatola - pcs per box: **12**

peso lordo - gross weight: **6.60Kg**

IMBALLO - PACKING

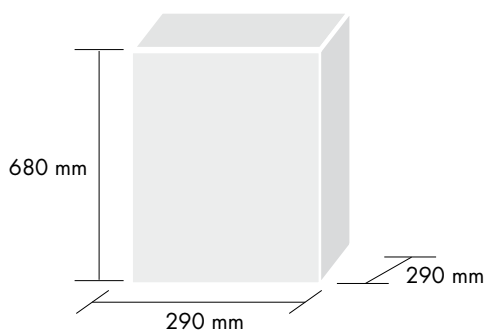

CODICE ARTICOLO - ARTICLE CODE

L5002

DESCRIZIONE - DESCRIPTION

Cestino in rete metallica traforata

Metal mesh waste bin

COLORI - COLOURS

argento - silver

nero - black

DETTAGLI TECNICI - TECHNICAL DATA

pezzi per scatola - pcs per box: **12**

peso lordo - gross weight: **6.40 Kg**

IMBALLO - PACKING

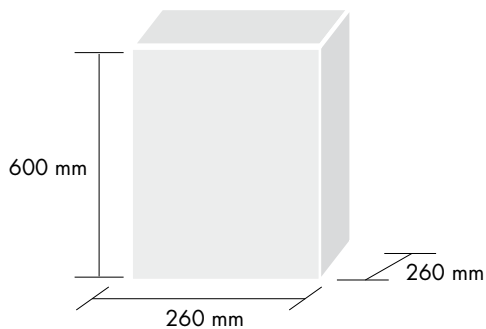



CODICE ARTICOLO - ARTICLE CODE

L6003 - L6004 - L6005

DESCRIZIONE - DESCRIPTION

Cestino in metallo senza fori, parzialmente forato o con fori

Metal waste bin without holes, with partial holes or with holes

COLORI - COLOURS

bianco - white

nero - black

argento - silver

DETTAGLI TECNICI - TECHNICAL DATA

pezzi per scatola - pcs per box: **06**

peso lordo - gross weight: **6 Kg**

IMBALLO - PACKING

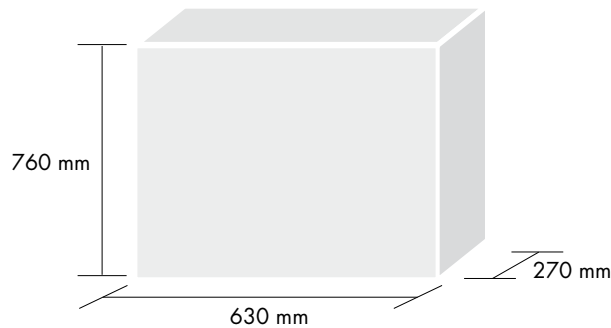

CODICE ARTICOLO - ARTICLE CODE

L8000 5LT

DESCRIZIONE - DESCRIPTION

Cestino in acciaio inox con pedale
Stainless steel pedal bin

DETTAGLI TECNICI - TECHNICAL DATA

pezzi per scatola - pcs per box: **06**

peso lordo - gross weight: **8 Kg**

IMBALLO - PACKING

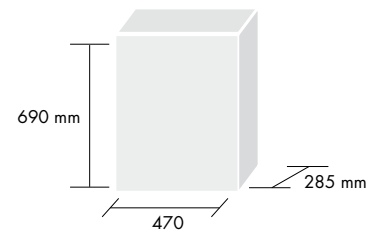

CODICE ARTICOLO - ARTICLE CODE

L8000 12LT

DESCRIZIONE - DESCRIPTION

Cestino in acciaio inox con pedale
Stainless steel pedal bin

DETTAGLI TECNICI - TECHNICAL DATA

pezzi per scatola - pcs per box: **04**

peso lordo - gross weight: **8.40 Kg**

IMBALLO - PACKING

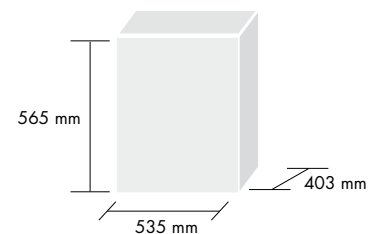

CODICE ARTICOLO - ARTICLE CODE

L8000 20LT

DESCRIZIONE - DESCRIPTION

Cestino in acciaio inox con pedale
Stainless steel pedal bin

DETTAGLI TECNICI - TECHNICAL DATA

pezzi per scatola - pcs per box: **04**

peso lordo - gross weight: **12.50 Kg**

IMBALLO - PACKING

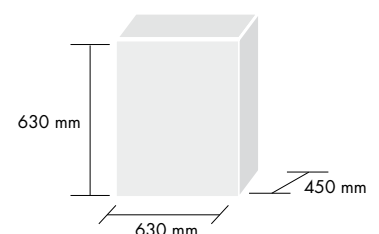



CODICE ARTICOLO - ARTICLE CODE

J3631

DESCRIZIONE - DESCRIPTION

Portaombrelli in rete metallica traforata

Metal mesh umbrella holder

COLORI - COLOURS

argento - silver

nero - black

DETTAGLI TECNICI - TECHNICAL DATA

pezzi per scatola - pcs per box: **06**

peso lordo - gross weight: **4.10 Kg**

IMBALLO - PACKING

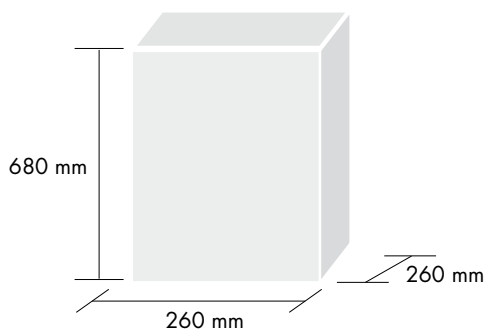

NEW



CODICE ARTICOLO - ARTICLE CODE

540 ORIONE

DESCRIZIONE - DESCRIPTION

Portaombrelli verniciato argento con accessori in legno e vaschetta raccogli gocce in plastica

Silver varnished umbrella holder with wooden fittings and plastic drop tray

COLORI - COLOURS

argento - silver

DETTAGLI TECNICI - TECHNICAL DATA

pezzi per scatola - pcs per box: **01**

peso lordo - gross weight: **3 Kg**

IMBALLO - PACKING

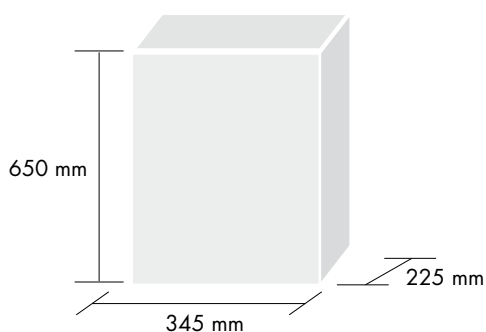



CODICE ARTICOLO - ARTICLE CODE

KIT 3514

DESCRIZIONE - DESCRIPTION

Kit scrivania ufficio

Office desk kit

COLORI - COLOURS

argento - silver

nero - black

DETTAGLI TECNICI - TECHNICAL DATA

pezzi per scatola - pcs per box: **06**

peso lordo - gross weight: **5.60 Kg**

IMBALLO - PACKING

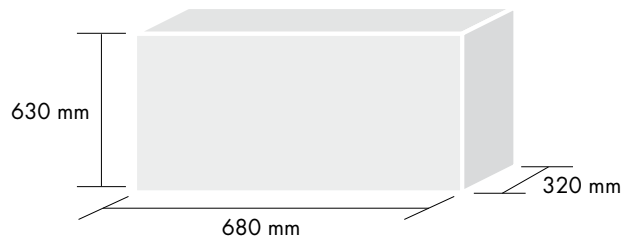

CODICE ARTICOLO - ARTICLE CODE

KIT 3577

DESCRIZIONE - DESCRIPTION

Kit scrivania ufficio

Office desk kit

COLORI - COLOURS

argento - silver

nero - black

DETTAGLI TECNICI - TECHNICAL DATA

pezzi per scatola - pcs per box: **06**

peso lordo - gross weight: **10.50 Kg**

IMBALLO - PACKING

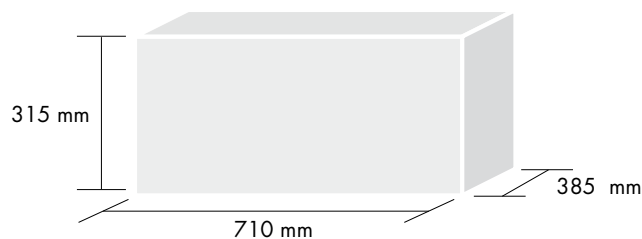



CODICE ARTICOLO - ARTICLE CODE

ORIONE A MURO CILIEGIO E COLORATO

DESCRIZIONE - DESCRIPTION

Appendiabito a muro con base e braccetti in metallo verniciato grigio e pomoli in legno

Wall hanger with frame and hooks in silver varnished metal and wooden spheres

DETTAGLI TECNICI - TECHNICAL DATA

pezzi per scatola - pcs per box: 01

COLORI POMOLI - SPHERES COLOURS

ciliegio - cherry wood

blu - blue

giallo - yellow

rosso - red

verde - green

1 posto - 1 hanger

peso lordo - gross weight: 0.35 Kg

imballo - packing: 100x120x190 mm

2 posti - 2 hangers

peso lordo - gross weight: 0.50 Kg

imballo - packing: 110x210x210 mm

3 posti - 3 hangers

peso lordo - gross weight: 0.84 Kg

imballo - packing: 110x350x210 mm

4 posti - 4 hangers

peso lordo - gross weight: 1.19 Kg

imballo - packing: 110x490x210 mm

5 posti - 5 hangers

peso lordo - gross weight: 1.53 Kg

imballo - packing: 110x630x210 mm

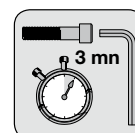
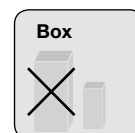
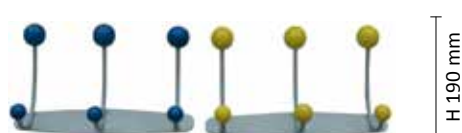
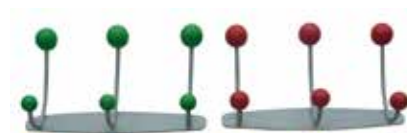
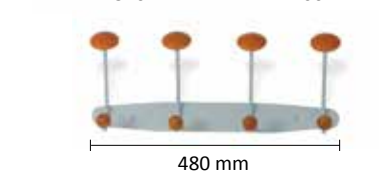
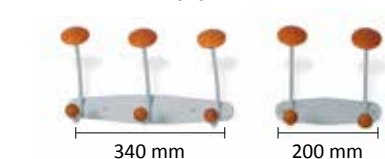
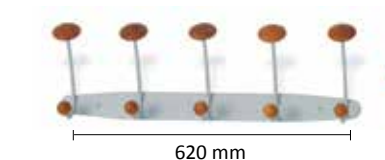

sporgenza - shelf
160 mm

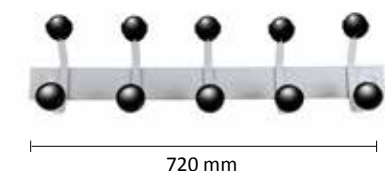
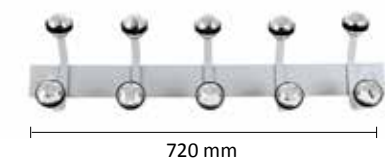
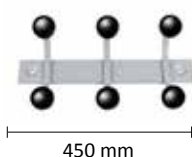
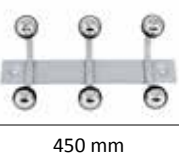
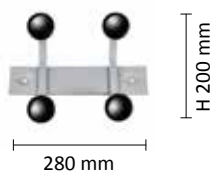
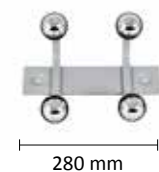

CODICE ARTICOLO - ARTICLE CODE

ELLE A MURO

DESCRIZIONE - DESCRIPTION

Appendiabito a muro con base e braccetti in metallo verniciato grigio e pomoli in plastica.

Wall hanger with frame and hooks in silver varnished metal and plastic spheres.

DETTAGLI TECNICI - TECHNICAL DATA

pezzi per scatola - pcs per box: 01

COLORI POMOLI - SPHERES COLOURS

cromate - chromed

nere - black

2 posti - 2 hangers

peso lordo - gross weight: 0.95 Kg

imballo - packing: 300x210x170 mm

3 posti - 3 hangers

peso lordo - gross weight: 1.30 Kg

imballo - packing: 450x210x170 mm

5 posti - 5 hangers

peso lordo - gross weight: 2.16 Kg

imballo - packing: 730x210x170 mm

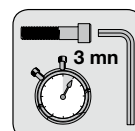
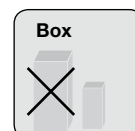

sporgenza - shelf
90 mm

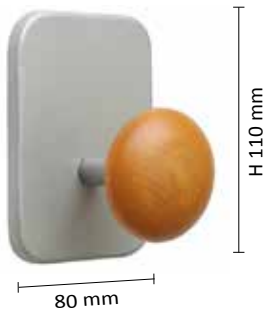

CODICE ARTICOLO - ARTICLE CODE

641 MAGNETICO

DESCRIZIONE - DESCRIPTION

Appendiabito a muro magnetico con base in metallo verniciato e pomello in legno

Magnetic wall hanger with metal varnished frame and wooden sphere

COLORI - COLOURS

argento - silver
nero - black

DETTAGLI TECNICI - TECHNICAL DATA

pezzi per scatola - pcs per box: **01**
peso lordo - gross weight: **0.20 Kg**

IMBALLO - PACKING

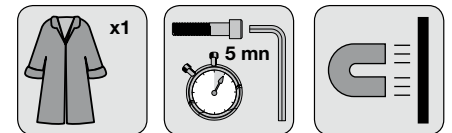
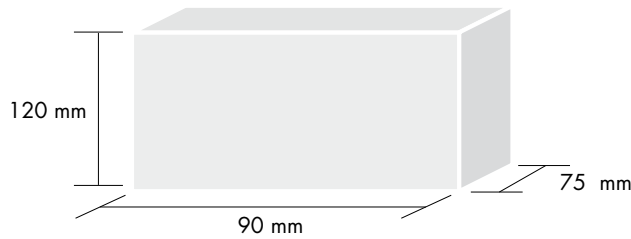

sporgenza - shelf
105 mm

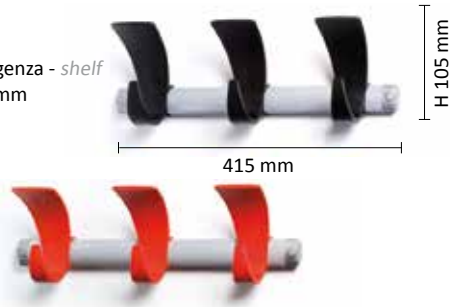

CODICE ARTICOLO - ARTICLE CODE

RICCIO A MURO

DESCRIZIONE - DESCRIPTION

Appendiabito a muro con telaio grigio in metallo e plastiche colorate

Wall hanger with silver metal frame and coloured plastic hangers

4 posti (plastiche arancio)
4 hangers (orange plastic fittings)
4 posti (plastiche blu)
4 hangers (blue plastic fittings)
4 posti (plastiche nere)
4 hangers (black plastic fittings)

peso lordo - gross weight: **1.13 Kg**
imballo - packing: **150x590x90 mm**
barra - frame: **570 mm**

DETTAGLI TECNICI - TECHNICAL DATA

pezzi per scatola - pcs per box: **01**

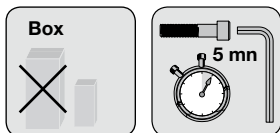

2 posti (plastiche arancio)
2 hangers (orange plastic fittings)
2 posti (plastiche blu)
2 hangers (blue plastic fittings)
2 posti (plastiche nere)
2 hangers (black plastic fittings)

peso lordo - gross weight: **0.61 Kg**
imballo - packing: **150x280x90 mm**
barra - frame: **260 mm**

3 posti (plastiche arancio)
3 hangers (orange plastic fittings)
3 posti (plastiche blu)
3 hangers (blue plastic fittings)
3 posti (plastiche nere)
3 hangers (black plastic fittings)

peso lordo - gross weight: **0.85 Kg**
imballo - packing: **150x435x90 mm**
barra - frame: **415 mm**

5 posti (plastiche arancio)
5 hangers (orange plastic fittings)
5 posti (plastiche blu)
5 hangers (blue plastic fittings)
5 posti (plastiche nere)
5 hangers (black plastic fittings)

peso lordo - gross weight: **1.43 Kg**
imballo - packing: **150x745x90 mm**
barra - frame: **725 mm**

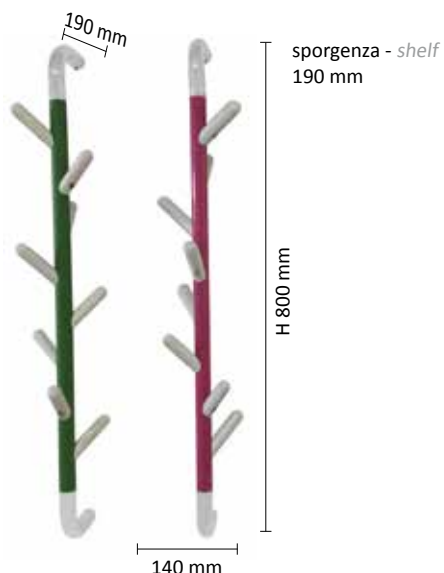

CODICE ARTICOLO - ARTICLE CODE

811 BRANCH A MURO

DESCRIZIONE - DESCRIPTION

Appendiabiti a muro ruotabile in metallo con braccetti bianchi e telaio colorato

Rotatable wall hanger made of metal with white hooks and colored frame

COLORI - COLOURS

verde/bianco - green /white
blu/bianco - blue/white
fucsia/bianco - fuchsia/white
grigio/bianco - grey/white

DETTAGLI TECNICI - TECHNICAL DATA

pezzi per scatola - pcs per box: **01**
peso lordo - gross weight: **1.50 Kg**

IMBALLO - PACKING

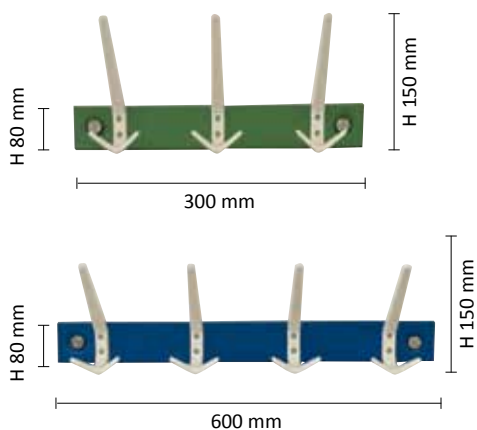
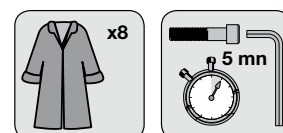
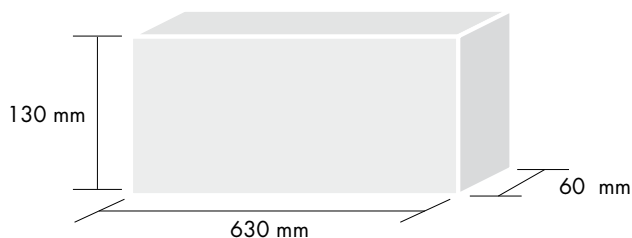

CODICE ARTICOLO - ARTICLE CODE

890 FRECCIA A MURO

DESCRIZIONE - DESCRIPTION

Appendiabito a muro con ganci bianchi in plastica e barra in metallo colorato

Wall hanger with white plastic hooks and metal colored board

DETTAGLI TECNICI - TECHNICAL DATA

pezzi per scatola - pcs per box: **01**

COLORI - COLOURS

verde/bianco - green/white
blu/bianco - blue/white
grigio/bianco - grey/white
fucsia/bianco - fuchsia/white

2 posti - 2 hangers

peso lordo - gross weight: **0.50 Kg**
imballo - packing: **300X150X80 mm**
barra - frame: **300 mm**

3 posti - 3 hangers

peso lordo - gross weight: **0.65 Kg**
imballo: - packing: **450x150x80 mm**
barra - frame: **450 mm**

4 posti - 4 hangers

peso lordo - gross weight: **0.85 Kg**
imballo: - packing: **600x150x80 mm**
barra - frame: **600 mm**

5 posti - 5 hangers

peso lordo - gross weight: **1 Kg**
imballo: - packing: **750x150x80 mm**
barra - frame: **750 mm**

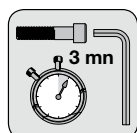

NEW



CODICE ARTICOLO - ARTICLE CODE

891 SKY A MURO

DESCRIZIONE - DESCRIPTION

Appendiabiti a muro in legno con ganci "apri e chiudi"

Wooden wall coat hangers with flapping hooks

2 ganci - 2 hooks

peso lordo - gross weight: **1.20 Kg**

imballo - packing: **250x170x40 mm**

misura - measure: **240x160x30 mm**

DETTAGLI TECNICI - TECHNICAL DATA

pezzi per scatola - pcs per box: **01**

3 ganci - 3 hooks

peso lordo - gross weight: **1.60 Kg**

imballo - packing: **385x170x40 mm**

misura - measure: **375x160x30 mm**

COLORI - COLOURS

bianco/grigio - white /grey

grigio/bianco - grey/white

naturale/bianco - natural wood/white

4 ganci - 4 hooks

peso lordo - gross weight: **2.04 Kg**

imballo - packing: **515x170x40 mm**

misura - measure: **505x160x30 mm**

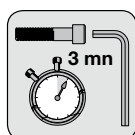

CODICE ARTICOLO - ARTICLE CODE

60x60

DESCRIZIONE - DESCRIPTION

Tavolo quadrato con struttura in metallo verniciato argento con due ripiani in vetro. Accessori in plastica nera.

Squared table composed by a metal varnished silver frame with two glass levels. Fittings made of black plastic.

COLORI - COLOURS

argento - silver



DETTAGLI TECNICI - TECHNICAL DATA

pezzi per scatola - pcs per box: **01**
peso lordo - gross weight: **19.30 Kg**

IMBALLO - PACKING

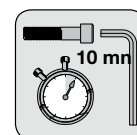
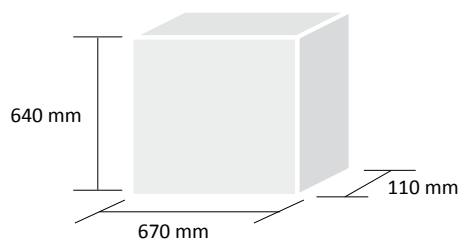

CODICE ARTICOLO - ARTICLE CODE

90x60

DESCRIZIONE - DESCRIPTION

Tavolo rettangolare con struttura in metallo verniciato argento con due ripiani in vetro. Accessori in plastica nera.

Rectangular table composed by a metal varnished silver frame with two glass levels. Fittings made of black plastic.

COLORI - COLOURS

argento - silver



DETTAGLI TECNICI - TECHNICAL DATA

pezzi per scatola - pcs per box: **01**
peso lordo - gross weight: **27.50 Kg**

IMBALLO - PACKING

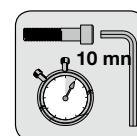
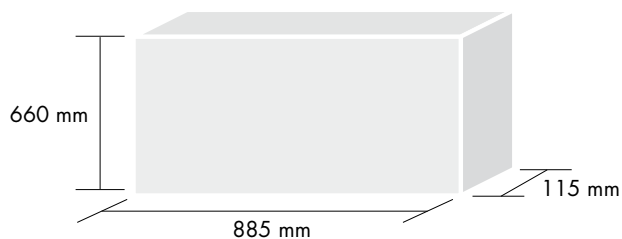

CODICE ARTICOLO - ARTICLE CODE

251V SPECCHIERA

DESCRIZIONE - DESCRIPTION

Specchiera con telaio metallico verniciato

Metal frame varnished mirror

DETTAGLI TECNICI - TECHNICAL DATA

pezzi per scatola - pcs per box: **01**

peso lordo - gross weight: **6.49 Kg**

minimo ordine: **4 pezzi**

minimum order quantity: 4 pcs

COLORI - COLOURS

arancione - orange

argento - silver

bianco - white

nero - black

rosso - red

verde - green

viola - purple

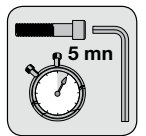
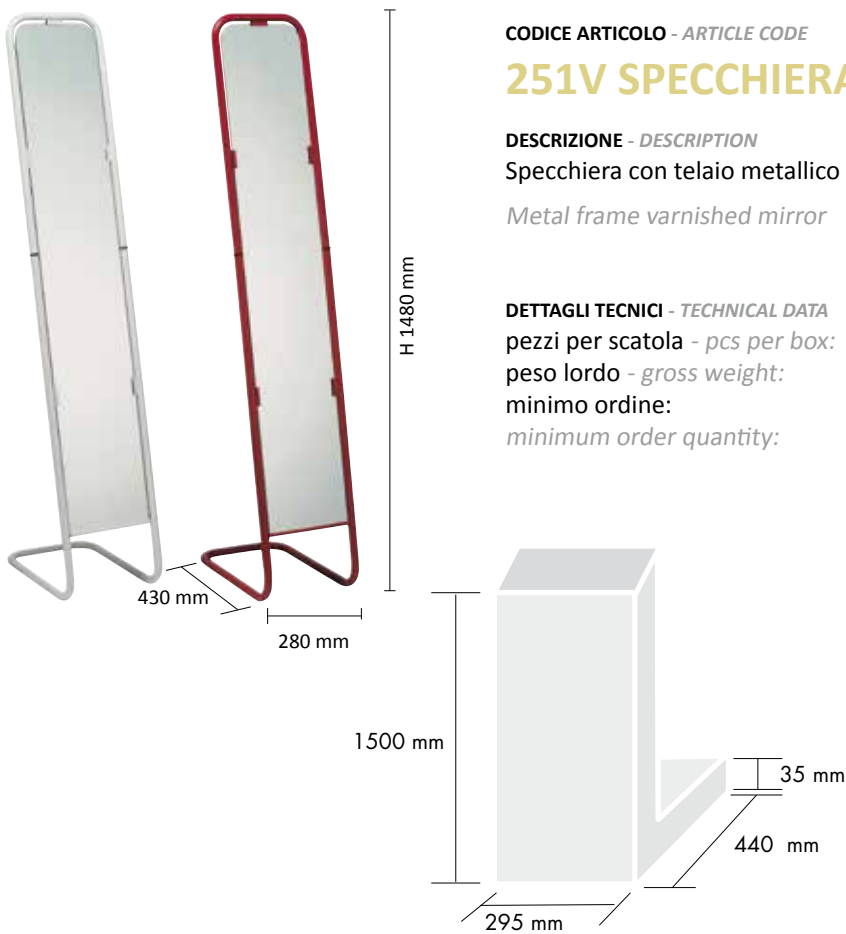



CODICE ARTICOLO - ARTICLE CODE

145

DESCRIZIONE - DESCRIPTION

Vestiario con cappelliera

Wardrobe with hat stand

COLORI - COLOURS

nero - black

DETTAGLI TECNICI - TECHNICAL DATA

pezzi per scatola - pcs per box: **01**

peso lordo - gross weight: **10.62 Kg**

cromato - chromed

IMBALLO - PACKING

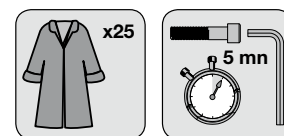
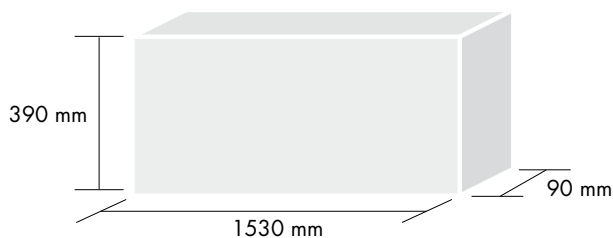

CODICE ARTICOLO - ARTICLE CODE

148

DESCRIZIONE - DESCRIPTION

Vestiario verniciato argento con barra cromata

Silver varnished wardrobe with chromed metal bar

COLORI - COLOURS

argento/cromato

silver/chromed

DETTAGLI TECNICI - TECHNICAL DATA

pezzi per scatola - pcs per box: **01**

peso lordo - gross weight: **6.65 Kg**

IMBALLO - PACKING

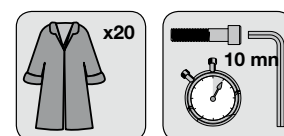
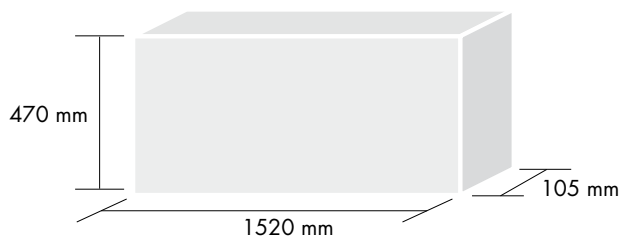

CODICE ARTICOLO - ARTICLE CODE

149

DESCRIZIONE - DESCRIPTION

Vestiario verniciato argento
con barra cromata estendibile e impilabile
*Silver varnished wardrobe
with extendible and stackable chromed
metal bar*

COLORI - COLOURS

argento/cromato
silver/chromed

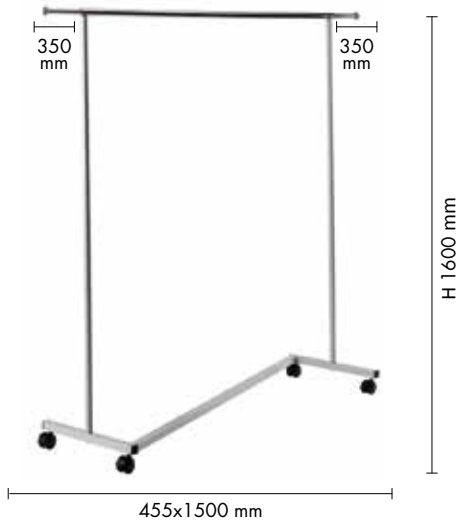

DETTAGLI TECNICI - TECHNICAL DATA

pezzi per scatola - pcs per box: **01**
peso lordo - gross weight: **6.93 Kg**

IMBALLO - PACKING

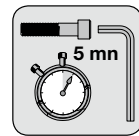
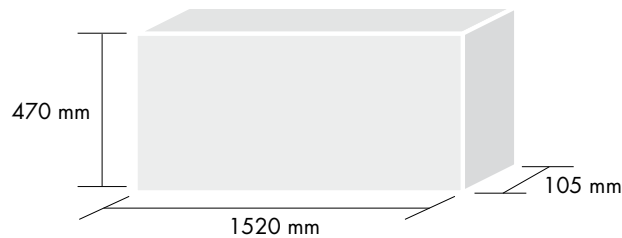

CODICE ARTICOLO - ARTICLE CODE

150

DESCRIZIONE - DESCRIPTION

Vestiario estendibile
Extendible wardrobe

COLORI - COLOURS

argento - silver



DETTAGLI TECNICI - TECHNICAL DATA

pezzi per scatola - pcs per box: **01**
peso lordo - gross weight: **7.19Kg**

IMBALLO - PACKING

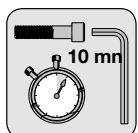
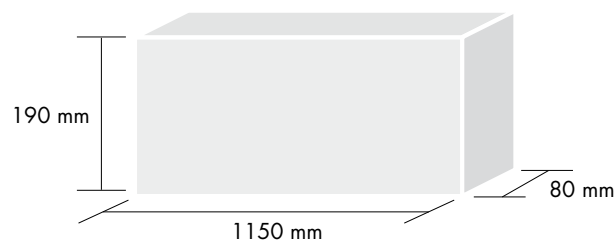

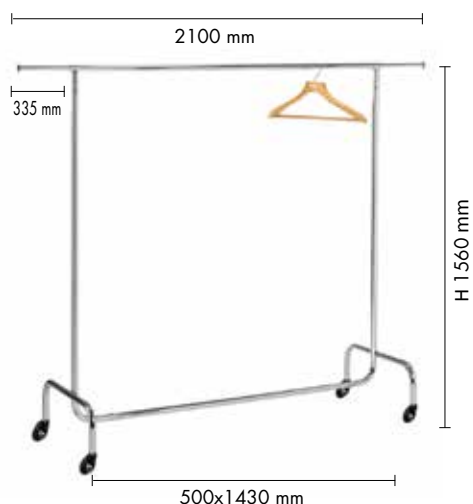

CODICE ARTICOLO - ARTICLE CODE

160

DESCRIZIONE - DESCRIPTION

Vestiario cromato estendibile

Extendible chromed wardrobe

COLORI - COLOURS

cromato - chromed

DETTAGLI TECNICI - TECHNICAL DATA

pezzi per scatola - pcs per box: **01**

peso lordo - gross weight: **8.30 Kg**

IMBALLO - PACKING

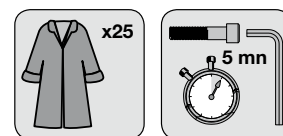
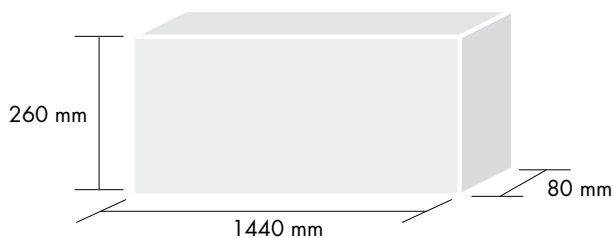

CODICE ARTICOLO - ARTICLE CODE

631 LOTUS

DESCRIZIONE - DESCRIPTION

Vestiario verniciato argento con cappelliera

Silver varnished wardrobe with hat stand

COLORI - COLOURS

argento - silver

DETTAGLI TECNICI - TECHNICAL DATA

pezzi per scatola - pcs per box: **01**

peso lordo - gross weight: **14.70 Kg**

IMBALLO - PACKING

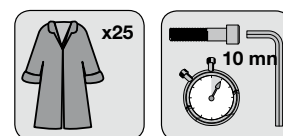
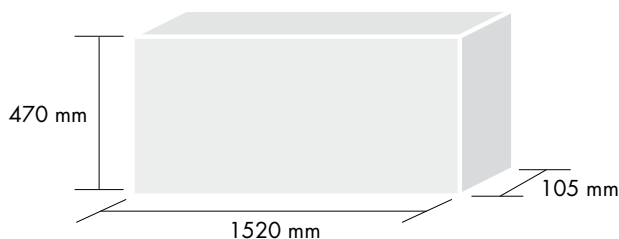



CODICE ARTICOLO - ARTICLE CODE

632 VESTIS

DESCRIZIONE - DESCRIPTION

Vestiario in metallo verniciato grigio o bianco con base fissa.
Barra per grucce cromata.

Varnished grey or white metal wardrobe with steel board. Chromed metal bar for coat hangers.

COLORI - COLOURS

grigio - grey
bianco - white

DETTAGLI TECNICI - TECHNICAL DATA

pezzi per scatola - pcs per box: **01**
peso lordo - gross weight: **20.60 Kg**

IMBALLO - PACKING

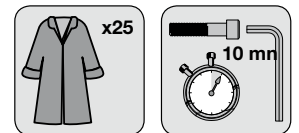
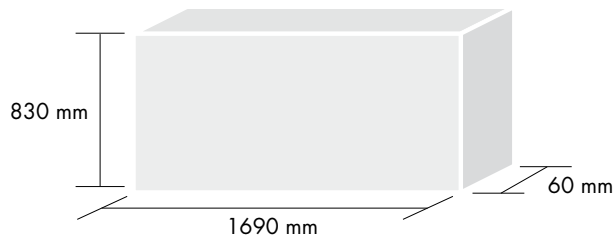

CODICE ARTICOLO - ARTICLE CODE

633 GLYCINE

DESCRIZIONE - DESCRIPTION

Vestiario verniciato argento con griglia e barra cromata

Silver varnished wardrobe with steel grid and chromed bar

COLORI - COLOURS

argento - silver

DETTAGLI TECNICI - TECHNICAL DATA

pezzi per scatola - pcs per box: **01**
peso lordo - gross weight: **8,35 Kg**

IMBALLO - PACKING

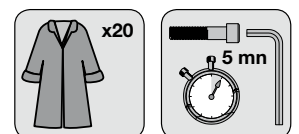
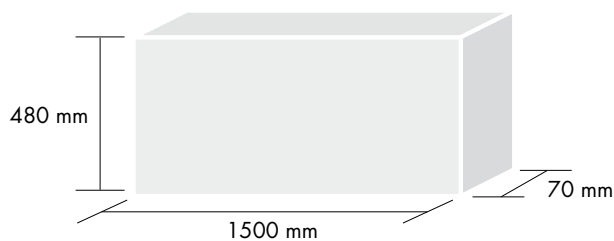

NEW



CODICE ARTICOLO - ARTICLE CODE

EASY TRASPARENTE

DESCRIZIONE - DESCRIPTION

Modello brevettato. Sedia impilabile, da utilizzo interno. Telaio: tubo tondo diam.18x1.4 mm cromato. Scocca in polipropilene copolimero non ignifuga trasparente.

Patented model. Stackable chair for indoor use. Frame: round tube Ø 18x1,4 mm chromed. Transparent shell in polypropylene copolymer, no fire retardant.

COLORI - COLOURS

bianco - white
verde - green
blu - blue
giallo - yellow
rosso - red
azzurro - light blue
arancio - orange



IMBALLO - PACKING

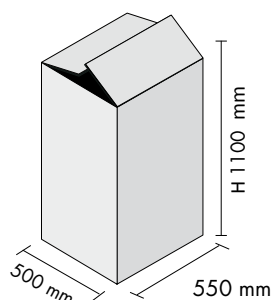

5 sedie per cartone
5 chairs per cardboard
0,30 m³

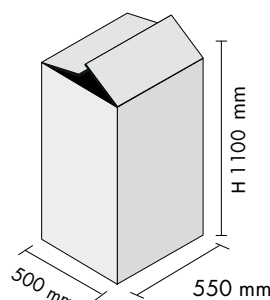

20 scocche per cartone
20 shells per cardboard
0,30 m³

DETTAGLI TECNICI - TECHNICAL DATA

peso lordo - gross weight: **3.16 Kg**

20 pz per pila
stack of 20 pcs.

5 pz per pila
stack of 5 pcs.

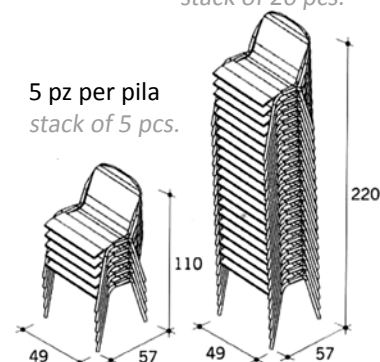

CODICE ARTICOLO - ARTICLE CODE

EASY

DESCRIZIONE - DESCRIPTION

Modello brevettato. Sedia impilabile, da utilizzo interno. Telaio: tubo tondo diam.18x1.4 mm cromato. Scocca in polipropilene copolimero non ignifuga.

Patented model. Stackable chair for indoor use. Frame: round tube Ø 18x1,4 mm chromed. Shell in polypropylene copolymer, no fire retardant.

COLORI - COLOURS

blu scuro - dark blue
grigio antracite - grey charcoal
grigio perla - pearl grey
verde scuro - dark green
nero - black
rosso - red
altri colori: su richiesta
other colors: on request



IMBALLO - PACKING

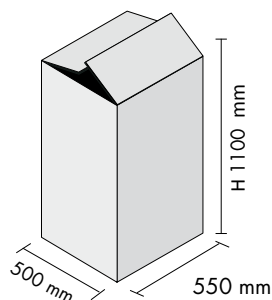

5 sedie per cartone
5 chairs per cardboard
0,30 m³

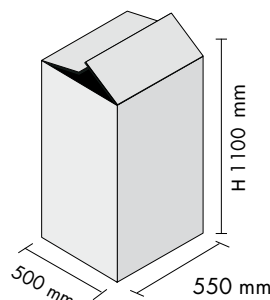

20 scocche per cartone
20 shells per cardboard
0,30 m³

DETTAGLI TECNICI - TECHNICAL DATA

peso lordo - gross weight: **3.16 Kg**

20 pz per pila
stack of 20 pcs.

5 pz per pila
stack of 5 pcs.

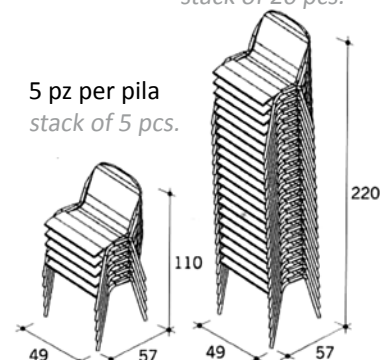



CODICE ARTICOLO - ARTICLE CODE

EASY CON TAVOLETTA

DESCRIZIONE - DESCRIPTION

Modello brevettato. Sedia impilabile, da utilizzo interno. Telaio: tubo tondo diam.18x1.4 mm cromato. Scocca in polipropilene copolimero non ignifuga con bracciolo porta tavoletta e snodo nero.

Patented model. Stackable chair for indoor use.

Frame: round tube Ø 18x1,4 mm chromed.

Shell in polypropylene copolymer, no fire retardant with writing tablet and black joint.

IMBALLO - PACKING

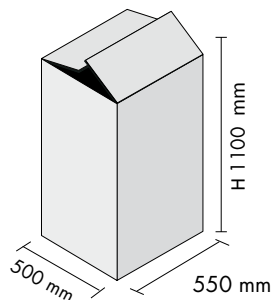

5 sedie per cartone
5 chairs per cardboard
0,30 m³

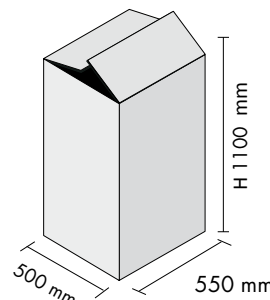

20 scocche per cartone
20 shells per cardboard
0,30 m³

COLORI - COLOURS

blu scuro - dark blue
grigio antracite - grey charcoal
grigio perla - pearl grey
verde scuro - dark green
nero - black
rosso - red

Su richiesta disponibili anche con scocca trasparente

Available on request transparent shell

COLORI TAVOLETTA - TABLE COLOURS

nero - black bianco - white

DETTAGLI TECNICI - TECHNICAL DATA

peso lordo - gross weight: **3.63 Kg**

20 pz per pila
stack of 20 pcs.

5 pz per pila
stack of 5 pcs.

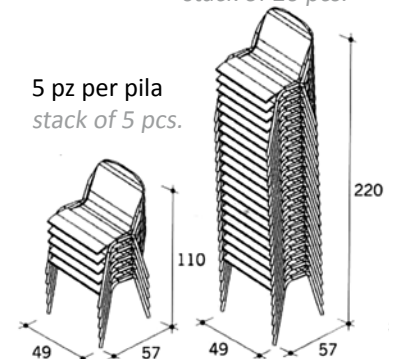

CODICE ARTICOLO - ARTICLE CODE

SALLY

DESCRIZIONE - DESCRIPTION

Modello brevettato. Sedia pieghevole da utilizzo interno. Telaio: tubo ellittico 30x15x1.5 mm cromato. Scocca in polipropilene copolimero, non ignifuga.

Patented model. Folding chair for indoor use.

Frame: chromed elliptical tube 30x15x1,5 mm.

Shell in polypropylene copolymer, no fire retardant.

IMBALLO - PACKING

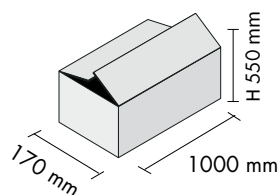

3 sedie per cartone
3 chairs per cardboard
0,095 m³

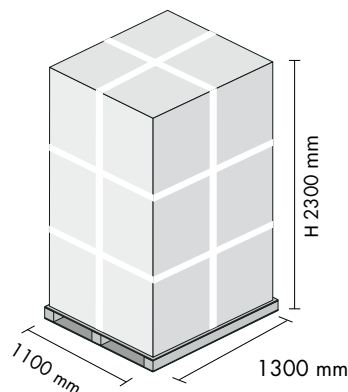

42 sedie per pallet
42 chairs per pallet
14 cardboard of 3pcs.
3,30 m³

COLORI - COLOURS

blu scuro - dark blue
grigio antracite - grey charcoal
grigio perla - pearl grey
verde scuro - dark green
nero - black
rosso - red

altri colori: su richiesta

other colors: on request

DETTAGLI TECNICI - TECHNICAL DATA

peso lordo - gross weight: **4 Kg**



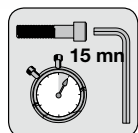

COLORI - COLOURS
argento - silver
nero - black

CODICE ARTICOLO - ARTICLE CODE

PANCA YD-B10

Panca per sala d'attesa in acciaio forato con profili, braccioli e gambe cromate, barra di sostegno nera. Per il modello 2-3-4P possibilità di aggiunta tavolino.

Waiting room chairs made of steel mesh with chromed edge, armrest and leg, black support beam. Steel table for 2-3-4p models available on request.



2 posti - 2 seats

DETTAGLI TECNICI - TECHNICAL DATA

peso lordo - gross weight: **22.00 Kg**

volume - volume: **0.070 cbm**

imballo - packing: **3 cartoni - 3 boxes**

1 cartone per sedute, 1 cartone per

coppia di braccioli e gambe,

1 cartone per barra

1 box for seats, 1 box for armrest

couple and legs, 1 box for beam

dimensioni panche montate

assembled benches size

1230x680x800 mm

altezza seduta - seat height: **400 mm**

3 posti o 2 posti con tavolino

3 seats or 2 seats with table

DETTAGLI TECNICI - TECHNICAL DATA

peso lordo - gross weight: **29.00 Kg**

volume - volume: **0.075 cbm**

imballo - packing: **3 cartoni - 3 boxes**

1 cartone per sedute, 1 cartone per

coppia di braccioli e gambe,

1 cartone per barra.

Aggiunta tavolo: **1 cartone**

1 box for seats, 1 box for armrest

couple and legs, 1 box for beam.

Table addition: **1 box**

dimensioni panche montate

assembled benches size

1805x680x800 mm

altezza seduta - seat height: **400 mm**

4 posti o 3 posti con tavolino

4 seats or 3 seats with table

DETTAGLI TECNICI - TECHNICAL DATA

peso lordo - gross weight: **37.50 Kg**

volume - volume: **0.130 cbm**

imballo - packing: **3 cartoni - 3 boxes**

1 cartone per sedute, 1 cartone per

coppia di braccioli e gambe,

1 cartone per barra

Aggiunta tavolo: **1 cartone**

1 box for seats, 1 box for armrest

couple and legs, 1 box for beam.

Table addition: **1 box**

dimensioni panche montate

assembled benches size

2380x680x800 mm

altezza seduta - seat height: **400 mm**

5 posti o 4 posti con tavolino

5 seats or 4 seats with table

DETTAGLI TECNICI - TECHNICAL DATA

peso lordo - gross weight: **44.50 Kg**

volume - volume: **0.150 cbm**

imballo - packing: **4 cartoni - 4 boxes**

2 cartone per sedute, 1 cartone per

coppia di braccioli e gambe,

1 cartone per barra

Aggiunta tavolo: **1 cartone**

1 box for seats, 1 box for armrest

couple and legs, 1 box for beam.

Table addition: **1 box**

dimensioni panche montate

assembled benches size

2955x680x800 mm

altezza seduta - seat height: **400 mm**



1030x590 mm

H 800 mm

CODICE ARTICOLO - ARTICLE CODE

PANCA EASY

DESCRIZIONE - DESCRIPTION

Modello brevettato. Panchina da utilizzo interno.

Trave: 40x80 cm verniciata nera.

Scocca in polipropilene copolimero, non ignifuga.

Patented model. Seats on beam for indoor use.

Beam: 40x80 cm black varnished.

Shell in polypropylene copolymer, no fire retardant.

COLORI - COLOURS

blu scuro - dark blue

grigio antracite - grey charcoal

grigio perla - pearl grey

verde scuro - dark green

nero - black

rosso - red

altri colori: su richiesta

other colors: on request

DETTAGLI TECNICI - TECHNICAL DATA

Panca 2 posti - 2 seats 1030x590x800 mm

Panca 3 posti - 3 seats 1550x590x800 mm

Panca 4 posti - 4 seats 2070x590x800 mm

Panca 5 posti - 5 seats 2590x590x800 mm

IMBALLO - PACKING

no standard (su richiesta) - No standard packaging (on request)

